



ARCHITECTURAL
GRATES + DRAINS



38PSG40

Linear Drain

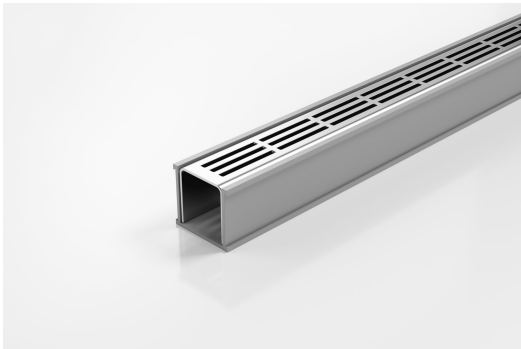

Stainless steel drainage unit with uPVC Channel and Fittings

The 38PS40 is a Punched Slot grate design.

Manufactured from 316 marine grade the 38PS is 38mm wide and 40mm deep.

Lengths over 3000mm available on request.

Refer to AS3500 for outlet pipe sizes specific to your installation.

Code 38PSG40

Range 38

Grate Style PS

Category Modular Kits

Channel Material uPVC

Steel Grade 316

SPECIFICATIONS + DIMENSIONS

Channel Width	46mm												
Channel Depth	42mm												
Length(s)	900mm	1000mm	1200mm	1500mm	1800mm	1900mm	2000mm	2200mm	2400mm	2700mm	3000mm	2100mm	2500mm
Outlet Size	DN40, DN50												

STORMTECH COLOUR FINISHES



Electroplate finishes subject to natural variation with time and local environment. Factors such as pools/surf beaches may require electropolishing. Contact us for suitability.

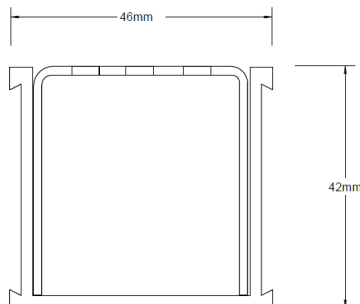

Grates longer than 1500mm supplied in sections. Tile Inserts longer than 1200mm supplied in sections. Channels over 3000mm supplied in sections with joiner. +/-2mm tolerance on dimensions.

PRODUCT APPLICATIONS

- | | |
|-----------------------------|----------------------------|
| Bathroom Drainage | Hospitality Drainage |
| Aged / Health Care Drainage | Paved Area Drainage |
| Balcony Drainage | Shower Drainage |
| Commercial Drainage | Multi-Residential Drainage |
| Courtyard / Patio Drainage | Special Needs Drainage |
| Pool and Spa Area Drainage | Threshold Drainage |

Copyright © Stormtech Pty Ltd. Patent 733361. Drawings not to scale, please use dimensions shown. Downloaded 15/06/2026 (please check for updates)



Visit stormtech.com.au
for tools + inspiration.

Phone **1300 653 403**

Email info@stormtech.com.au